

Data Sheet



Article number: 0121072

Description: Retaining ring JL 55X2
Spring steel

Measures

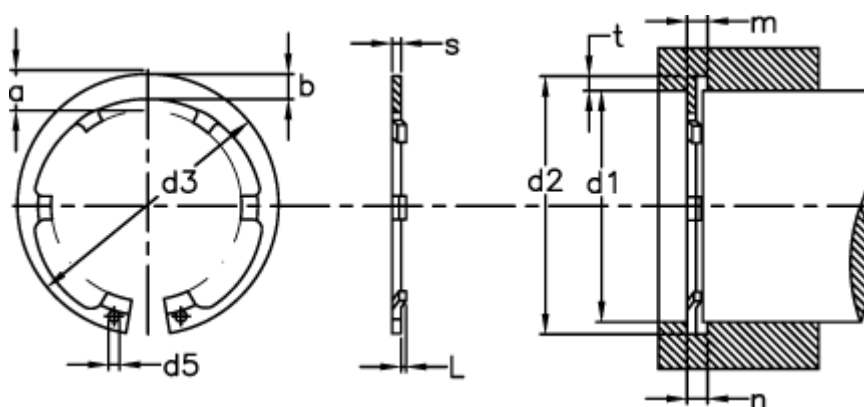

a max	= 8.2	FL max kN	= 1.45	s	= 2.00
b	= 5.1	FN kN	= 44.4	tol	= 0.30
C kN/mm	= 2.64	FRg kN	= 12.50	tol	= +1,10 -0,46
d1	= 55	FR kN	= 60.30	u	= 0.10
d2	= 58.0	g	= 2.0		
d3	= 59.2	L min	= 0.65		
d5 min	= 2.5	m min	= 2.15		
Description	= AL 55	Nominal drive	= 4.5		